

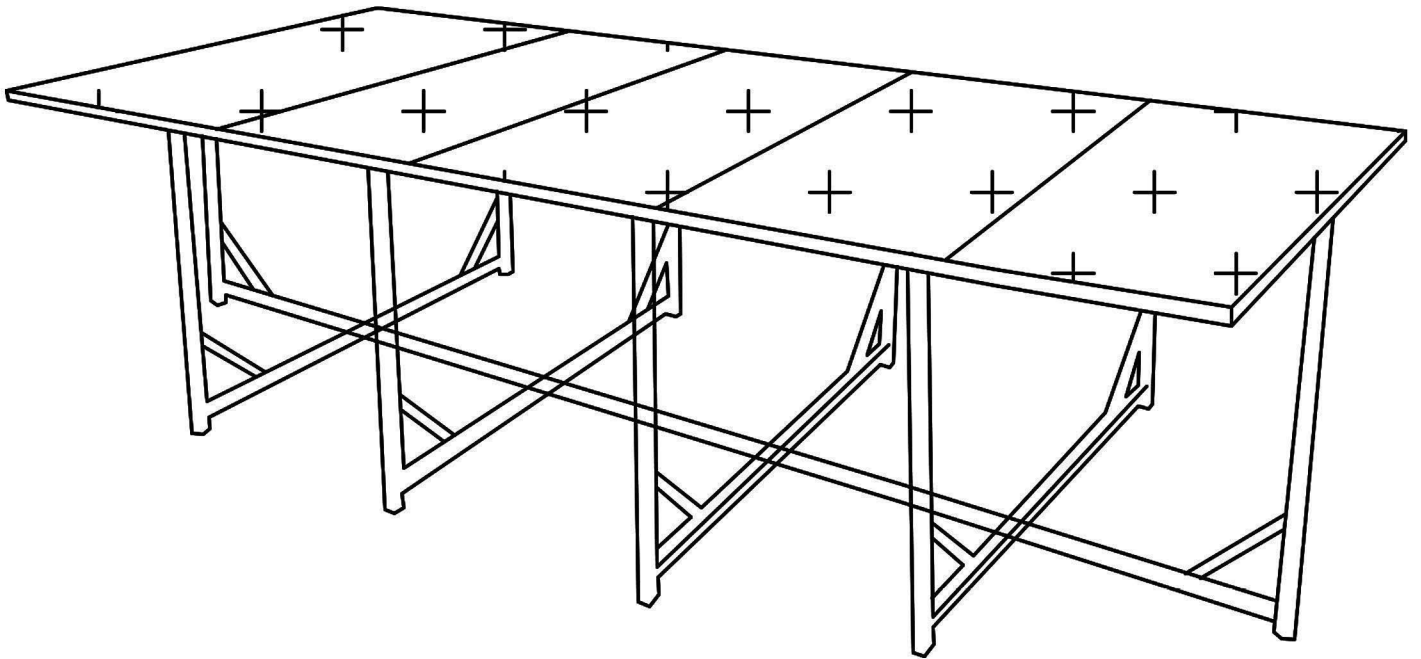

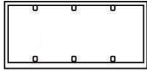

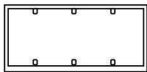

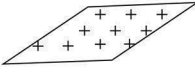

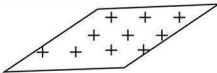
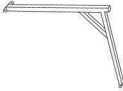

Chicago 10

1165_86749/1165_86750/1165_86751



1165_86749/86750/86751

A1		1085X575mm	X2	1/1
A2		1085X575mm	X3	1/1
B1		1022X537mm	X3	1/1
B2		1022X525mm	X2	1/1
J		560X690mm	X2	1/1
K		1085X690mm	X4	1/1
L		545X30mm	X3	1/1
P1		M6X45mm	X8	1/1
P2		M6X35mm	X8	1/1
P5		M6X20mm	X20	1/1
Q		Ø6X1mm	X36	1/1
R		M6	X16	1/1
S		M6	X1	1/1
T		M6	X1	1/1
U		20x20mm	X4	1/1

FR : SAV//INFORMATION /VIDEO/CONTACT
 EN: AFTER-SALES SERVICE//INFORMATION/VIDEO/CONTACT
 DE : REPARATUR-SERVICE UND ERSATZTEILE //INFORMATIONEN /VIDEO/KONTAKT
 ES: SERVICIO POST-VENTA//INFORMACIÓN/VIDEO/CONTACTO
 IT: SERVIZIO ASSISTENZA//INFORMAZIONI/VIDEO/CONTATTO
 PT: SERVIÇO PÓS-VENDA//INFORMAÇÕES/VIDEO/CONTATO
 PL: SERWIS TECHNICZNY//INFORMACJE/WIDEO/KONTAKT
 NE: AFTER SALES SERVICE//INFORMATIE/VIDEO/CONTACT
 HE: עם לתקשר/הווידיאו/ מידע/ומכירות שירות לאחר

SAV.HABITATETJARDIN.COM

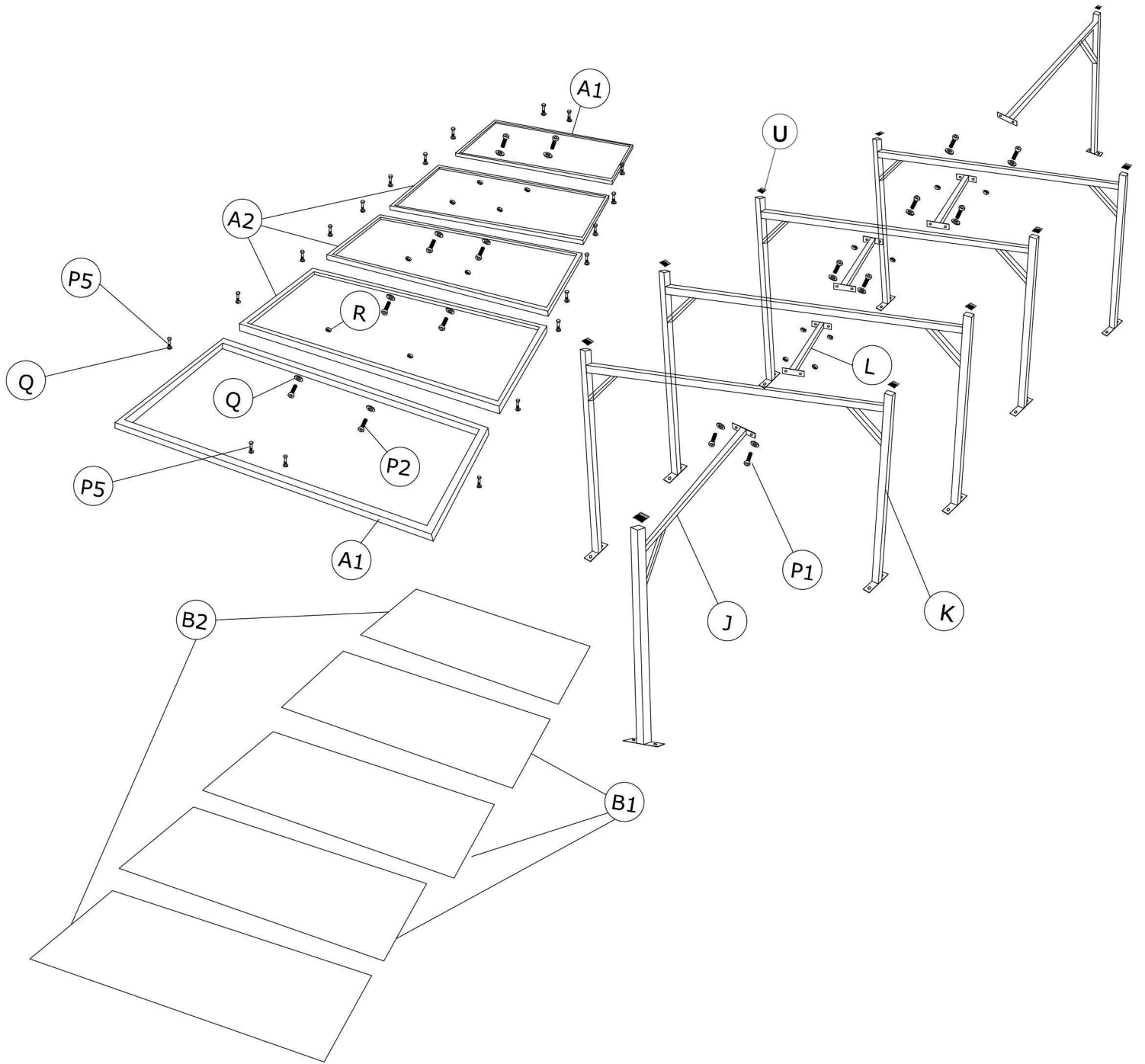

FR

- Il est conseillé d'attendre d'avoir monté entièrement votre produit avant de serrer complètement vos vis.
- Evitez d'exposer le plateau de verre directement aux rayons de soleil lors de fortes chaleurs.
- Il est conseillé de protéger vos produits à l'aide d'une housse de protection afin de les préserver des intempéries et de la poussière.
- En hiver, stockez vos produits à l'abri dans un endroit sec.
- Ne jamais utiliser des produits chimiques pour le nettoyage.

EN

- It is advisable to wait until you have fully assembled your product before tightening your screws completely.
- Avoid exposing the glass tray under sunlight during high heat.
- It is advisable to put your products into cover to protect them from the severe weather and dust.
- In winter, store your products in a dry place.
- Never use chemical products for cleaning.

DE

- Es ist ratsam, für Ihre vollständig montiert zu warten, bevor vollständig Ihre Schrauben festziehen.
- Vermeiden Sie die Glasschale direkt mit Sonnenlicht während der schweren Hitze auszusetzen.
- Es wird empfohlen, Ihre Produkte mit einer Schutzabdeckung zum Schutz vor Witterung und Staub zu schützen.
- Im Winter, speichern Sie Ihre Waren an einem trockenen Ort.
- Verwenden Sie niemals Chemikalien zur Reinigung.

ES

- Se aconseja montar totalmente el producto antes de apretar completamente todos los tornillos.
- Se aconseja cubrir los productos con una funda para protegerlos de las intemperies y del polvo.
- Seque inmediatamente su mobiliario para evitar las marcas.
- En invierno, almacene los productos en un lugar seco.
- Nunca utilice productos químicos para la limpieza.

IT

- È consigliato di aspettare di avere montato interamente il prodotto prima di stringere completamente le viti.
- Evitate di esporre direttamente il vassoio di vetro al sole soprattutto durante i periodi di gran calore.
- È consigliato di proteggere i prodotti con un sacco di protezione per preservarli dal brutto tempo e dalla polvere.
- Durante l'inverno, mettere i prodotti al riparo in un luogo secco.
- Mai usare prodotti chimici per pulire i prodotti.

